

# User Manual

**DE-645**

**Type N2...**



**Electrolux**  
PROFESSIONAL





# WARNING:

## **FIRE OR EXPLOSION HAZARD**

Failure to follow safety warnings exactly could result in serious injury, death or property damage.

Do not store or use gasoline or other flammable vapors and liquids in the vicinity of this or any other appliance.

## **WHAT TO DO IF YOU SMELL GAS:**

- Do not try to light any appliance.
- Do not touch any electrical switch; do not use any phone in your building.
- Clear the room, building or area of all occupants.
- Immediately call your gas supplier from a neighbor's phone. Follow the gas supplier's instructions.
- If you cannot reach your gas supplier, call the fire department.

Installation and service must be performed by a qualified installer, service agency or the gas supplier.

The above information; "What to do if you smell gas", shall be posted in a prominent location. The information to be posted shall be obtained by consulting with the local gas supplier.

# FOR YOUR SAFETY

Do not store or use gasoline or other flammable vapors and liquids in the vicinity of this or any other appliance.

The above information; "For your safety", shall be posted in a prominent location.

MAKE CERTAIN TO KEEP THIS MANUAL IN A SECURE PLACE FOR FUTURE REFERENCE.



# **WARNING:**

**This conversion kit shall be installed by a qualified service agency in accordance with the manufacturer's instructions and all applicable codes and requirements of the authority having jurisdiction. If the information in these instructions is not followed exactly, a fire, explosion or production of carbon monoxide may result causing property damage, personal injury or loss of life. The qualified service agency is responsible for the proper installation of this kit. The installation is not proper and complete until the operation of the converted appliance is checked as specified in the manufacturer's instructions supplied with the kit.**

**WARNING:** The dryer is intended for use only with fabrics that have been washed with water.

**WARNING:** To avoid fire hazard, do not dry articles containing foam rubber or similarly textured rubberlike materials.

**WARNING:** ALL OPERATING AND MAINTENANCE PROCEDURES SHOWN ON THE NEXT PAGE OF THIS MANUAL MUST BE FOLLOWED DAILY FOR PROPER OPERATION OF YOUR MACHINE.

Keep the dryer area clear and free from combustible materials, gasoline, and other flammable vapors and liquids.

The dryer must not be installed or stored in an area where it will be exposed to water and/or weather.

PLEASE ENTER THE FOLLOWING INFORMATION AS IT APPEARS ON THE MACHINE(S) DATA PLATE(S).

MACHINE TYPE OR MODEL	
MACHINE SERIAL NUMBER(S)	
ELECTRICAL CHARACTERISTICS: _____ VOLTS, _____ PHASE, _____ HZ.	

**Warning: For your safety the information in this manual must be followed to minimize the risk of fire or explosion or to prevent property damage, personnel injury or death.**

## **NOTICE TO: OWNERS, OPERATORS AND DEALERS**

IMPROPER INSTALLATION AND INADEQUATE MAINTENANCE, POOR HOUSEKEEPING AND WILLFUL NEGLIGENCE OR BYPASSING OF SAFETY DEVICES MAY RESULT IN SERIOUS ACCIDENTS OR INJURY. TO ASSURE THE SAFETY OF CUSTOMERS AND/OR OPERATORS OF YOUR MACHINE, THE FOLLOWING MAINTENANCE CHECKS MUST BE PERFORMED ON A DAILY BASIS.

1. **Prior to operation of the machine**, check to make certain that all operating instructions and warning signs are affixed to the machine and legible. Missing or illegible ones must be replaced immediately. Be sure you have spare signs and labels available at all times. These can be obtained from your dealer.
2. **Check the door safety interlock, as follows:**
  - a. OPEN THE DOOR of the machine and attempt to start in the normal manner:  
For coin-operated models, insert the proper coins to start the machine.  
For manually operated models, place the ON-OFF switch in the ON position and press the Start switch.

## **THE MACHINE(S) MUST NOT START !**

3. DO NOT UNDER ANY CIRCUMSTANCES ATTEMPT TO BYPASS OR REWIRE ANY OF THE MACHINE SAFETY DEVICES AS THIS CAN RESULT IN SERIOUS ACCIDENTS.
4. **Be sure to keep the machine(s) in proper working order:** Follow **all** maintenance and safety procedures. Further information regarding machine safety, service and parts can be obtained from your dealer.  
All requests for assistance must include the model, serial number and electrical characteristics as they appear on the machine identification plate. Insert this information in the space provided on the previous page of this manual.
5. **WARNING:** DO NOT OPERATE MACHINE(S) WITH SAFETY DEVICES BYPASSED, REWIRED OR INOPERATIVE! DO NOT OPEN MACHINE DOOR UNTIL DRUM HAS STOPPED ROTATING!

---

## NOTICE TO INSTALLER

Improper installation of this machine:

- May cause serious damage to the machine.
- May result in other property damage.
- May cause personal injury.
- Will void the manufacturer's warranty.

Connection to line Voltage or over-current protection devices other than those specified on the data plate may result in severe damage to machine components, and will void the manufacturer's warranty.

Refer to complete installation instructions provided in manuals accompanying the machine.

**Contact Electrolux Professional Technical Support with any questions BEFORE installing this machine. Damage resulting from inadequate installation materials or improper installation techniques will void the manufacturer's warranty.**

## Electrical Information

It is your responsibility to have **ALL** electrical connections (including grounding) made by a properly licensed and competent electrician to assure that the electrical installation is adequate and conforms with local and state regulations or codes.

In the absence of such codes, ALL electrical connections, material, and workmanship must **conform** to the applicable requirements of the NATIONAL ELECTRIC CODE ANSI/NFPA NO. 70 or the CANADIAN ELECTRICAL CODE, CSA C22.1 - both the latest edition.

**IMPORTANT:** Failure to comply with these codes or ordinances and/or the requirements stipulated in this manual can result in personal injury or component failure.

**NOTE:** Component failure due to improper installation will **VOID THE WARRANTY**.

**IMPORTANT:** A separate circuit serving each dryer must be provided. The dryer must be connected to copper wire only. **DO NOT** use aluminum wire which could cause a fire hazard.

**NOTE:** The use of aluminum wire will **VOID THE WARRANTY**

**CAUTION:** Label all wires prior to disconnection when servicing controls. Wiring errors can cause improper operation or component failure.

## Electrical Service

### Steam and gas dryers **ONLY**

**IMPORTANT:** The dryer must be connected to the electrical supply shown on the data label affixed to the dryer. In the case of 208 VAC or 240 VAC, the supply voltage **must match** the electric service specifications of the data label **exactly**. Wire **must be** properly sized to handle the rated current.

**WARNING:** 120 VAC, 208 VAC and 240 VAC ARE NOT THE SAME. Any damage done to dryer components due to improper voltage connections will **VOID THE WARRANTY**.



### Electric dryers **ONLY**

**IMPORTANT:** ALL electrically heated dryers must be connected to the electric supply service shown on the dryers data label which is affixed to the back side of the control (service) door. The connecting wires must be properly sized to handle the rated current.

**NOTE:** Component failure due to improper voltage application will **VOID THE WARRANTY**.



## Gas Information

It is your responsibility to have **ALL** plumbing connections made by a qualified professional to insure that the installation is adequate and conforms with local and state regulations or codes. In the absence of such codes, **ALL** plumbing connections, material, and workmanship must conform to the applicable requirements of **National Fuel Gas Code, ANSI Z223.1/NFPA 54**, or the **Natural Gas and Propane Installation Code, CSA B149.1** - both the latest edition.

On dryers not equipped with a gas union in the dryer manifold, the instructions shall specify that a listed connector in compliance with the **Standard for Connectors for Gas Appliances ANSI Z21.24 CSA 6.10**, be used to connect the dryer to the supply piping.

**IMPORTANT:** Failure to comply with these codes or ordinances, and/ or the requirements stipulated in this manual, can result in personal injury and improper operation of the dryer.

The dryer **must be** isolated from the gas supply piping system by closing its individual manual shut-off valve during any pressure testing of the gas supply piping system at test pressures equal to or greater than 1/2 psig (3.5 kPa).

**IMPORTANT:** Failure to isolate or disconnect the dryer from the gas supply as noted can cause irreparable damage to the gas valve and will **VOID THE WARRANTY**.

**WARNING:** **FIRES or EXPLOSION COULD RESULT.**



### Gas Supply

**NOTE:** Undersized gas piping will result in ignition problems, slow drying, increased use of energy, and can create a safety hazard.

The dryer **must be** connected to the type of heat/ gas indicated on the dryer data label. If this information does not agree with the type of gas available, **do not** operate the dryer, contact your local dealer.

**IMPORTANT:** Any burner changes or conversions must be made by a qualified licensed professional.

The input ratings shown on the dryer data label are for elevations of up to 1,999 feet. The adjustment or conversion of the dryer(s) in the field for elevations over 2,000 feet are made by changing each burner orifice. If these conversions are necessary, contact your local dealer.

## Natural Gas

If the pressure is too low, ignition failure and/or slow drying times may result. Excessively high supply pressure will result in erratic operation of the gas valves internal pressure regulator. Further information in section: Gas connection.

## Propane Gas

Dryers made for use with propane gas have the gas valve pressure regulator blocked open, so that the gas pressure **must be** regulated upstream of the dryer. In accordance with American Gas Association (AGA) standards, a gas pressure regulator, when installed indoors, must be equipped with a vent limiter or a vent line must be installed from the gas pressure regulator vent to the outdoors. The water column pressure **must be** regulated at the source (propane tank), or an external regulator must be added to each dryer. Further information in section: Gas connection.

## Piping/Connections

The dryer is provided with a 1/2" or a 3/4" N.P.T. inlet pipe connection extending out the rear area or through the top of the dryer. For ease of servicing, the gas supply line of each dryer should have its own shut-off valve.

The size of the gas supply line (header) will vary depending on the distance this supply line travels from the gas meter or, in the case of propane gas, the supply tank, the number of tees, other gas-operated appliances, etc. Specific information regarding supply line size should be determined by the gas supplier.

**NOTE:** Undersized gas supply piping can create a low or inconsistent gas pressure which will result in erratic operation of the burner ignition system.

Consistent gas pressure is essential at **ALL** gas connections. It is recommended that a 3/4- inch pipe gas loop be installed in the supply line serving the bank of dryers. An in-line pressure regulator **must be** installed in the gas supply line (header) if (natural) gas line pressure exceeds 12-inches water column pressure.

**IMPORTANT:** The information regarding the settings of the water column pressure for Natural gas dryers and Propane gas dryers is found in section: Gas connection. The pressure is required at the gas valve pressure tap of each dryer for proper and safe operation.

A 1/8" N.P.T. plugged tap, accessible for test gauge connection, **must be** installed in the main gas supply line immediately upstream of each dryer.

**IMPORTANT:** Pipe joint compounds that resist the action of natural gas and propane gas **MUST BE** used.

**WARNING:** Test **ALL** connections for leaks by brushing on a soapy water solution (liquid detergent also works well). **NEVER TEST FOR GAS LEAKS WITH AN OPEN FLAME.**

ALL components / materials **must conform** to NATIONAL FUEL GAS CODE specifications. It is important that gas pressure regulators meet applicable pressure requirements and that gas meters are rated for the total amount of appliance BTU's being supplied.

# Contents

---

## Contents

1	Safety Precautions .....	13
1.1	Additional safety precautions for gas heated tumble dryer .....	15
1.2	General information .....	15
1.3	Commercial use only .....	15
1.4	Copyright .....	15
1.5	Ergonomics certification .....	15
1.6	Symbols .....	16
2	Warranty terms and exclusions .....	17
3	Operating panel .....	18
4	Program description .....	19
4.1	General .....	19
4.2	Program description .....	19
4.3	Automatic fan control .....	21
5	Handling .....	21
5.1	Load .....	21
5.2	How to start the machine .....	23
5.3	Additional functions .....	23
5.4	When program has ended .....	24
6	Error codes .....	26
7	Maintenance .....	27
7.1	General .....	27
7.2	Time for maintenance .....	27
7.3	Every day .....	27
7.4	Machines with heat pump .....	29
7.4.1	Second lint filter .....	29
8	Disposal information .....	30
8.1	Disposal of appliance at end of life .....	30
8.2	Disposal of packing .....	30

The manufacturer reserves the right to make changes to design and component specifications.



## 1 Safety Precautions

- Servicing shall be carried out only by authorized personnel.
- Only authorized spare parts, accessories and consumables shall be used.
- The machine is not to be used if industrial chemicals have been used for cleaning.
- Do not dry unwashed items in the machine.
- Items that have been soiled with substances such as cooking oil, acetone, alcohol, petrol, kerosene, spot removers, turpentine, waxes and wax removers should be washed in hot water with an extra amount of detergent before being dried in the machine.
- Items such as foam rubber (latex foam), shower caps, waterproof textiles, rubber backed articles and clothes or pillows fitted with foam rubber pads should not be dried in the machine.
- Fabric softeners or similar products should be used as specified by the fabric softener instructions.
- The final part of a drying cycle occurs without heat (cool down cycle) to ensure that the items are left at a temperature that ensures that the items will not be damaged.
- Remove all objects from pockets such as lighters and matches.
- **WARNING.** Never stop the machine before the end of the drying cycle unless all items are quickly removed and spread out so that the heat is dissipated.
- Adequate ventilation has to be provided to avoid the back flow of gases into the room for appliances burning other fuels, including open fires.
- Exhaust air must not be discharged into a flue which is used for exhausting fumes from appliances burning gas or other fuels.
- The machine must not be installed behind a lockable door, a sliding door or a door with a hinge on the opposite side to that of the machine in such a way that a full opening of the machine is restricted.
- If the machine has a lint trap this has to be cleaned frequently.
- The lint must not be accumulated around the machine.
- **DO NOT MODIFY THIS APPLIANCE.**
- When performing service or replacing parts, the power must be disconnected.
- When the power is disconnected, the operator must see that the machine is disconnected (that the plug is removed and remains removed) from any point to which he has access. If this is not possible, due to the construction or installation of the machine, a disconnection with a locking system in the isolated position shall be provided.
- In accordance with the wiring rules: mount a multi-pole switch prior to the machine to facilitate installation and service operations.
- Stationary appliances not fitted with means for disconnection from the supply mains having a contact separation in all poles that provide full disconnection under overvoltage category III, means for disconnection must be incorporated in the fixed wiring in accordance with the wiring rules.
- **WARNING:** The appliance must not be supplied through an external switching device, such as a timer, or connected to a circuit that is regularly switched on and off by a utility.
- If different rated voltages or different rated frequencies (separated by a /) are stated at the machine data plate, instructions for adjusting the appliance for operation at the required rated voltage or rated frequency are stated in the installation manual.
- The openings in the base, shall not be obstructed by a carpet.
- Maximum mass of dry cloth: 20 kg / 44 lbs.

- A-weighted emission sound pressure level at working stations: 70 dB(A).

### 1.1 Additional safety precautions for gas heated tumble dryer

- Before installation, check that the local distribution conditions, nature of gas and pressure and the adjustment of the appliance are compatible.
- The machine is not to be installed in rooms containing cleaning machines with perchloroethylene, TRICHLOROETHYLENE or CHLOROFLUOROCONTAINING HYDROCARBONS as cleaning agents.
- NOTE: it is pointed out that the connection and commissioning of appliances complying with this standard are subject to observance of the installation regulations in force in the countries where these appliances are marketed.
- Connection to the appliance shall be made with a flexible hose suitable for the appliance category in accordance with national installation regulations of the country of destination and that in case of doubt the installer shall contact the supplier.
- The appliance should be installed on non-flammable materials for the floor, worktop and/or wall close to the appliance if required.
- If you can smell gas:
  - Do not switch on any equipment
  - Do not use electrical switches
  - Do not use telephones in the building
  - Evacuate the room, building or area
  - Contact the person responsible for the machine

### 1.2 General information

Conditions for storage and transportation of the appliance should fulfil a temperature between -20°C / + 70°C and max Humidity of 95% RH.

In order to prevent damage to the electronics (and other parts) that may occur as the result of condensation, the machine should be placed in room temperature for 24 hours before being used for the first time.

Electric power supply should follow:

- Max range for each country rated voltage: -15% / +10%.
- Max range for each country rated frequency:  $\pm 3$  Hz.
- Dips/Interruption: 5 Dips/day (100% voltage lost, with 3-4 minutes duration).

A stable power supply is always the best. Fluctuations gives stress and additional load on all electric and electronic components.

### 1.3 Commercial use only

The machine/machines covered by this manual is/are made for commercial and industrial use only.

### 1.4 Copyright

This manual is intended solely for consultation by the operator and can only be given to third parties with the permission of Electrolux Professional AB company.

### 1.5 Ergonomics certification

The human body is designed for movement and activity but physical stress injuries as a result of static and repetitive movements or unfavorable working postures may occur.

The ergonomic features of your product, the ones which may influence your physical and cognitive interaction with it, have been assessed and certified.

A product which exhibits ergonomic features, in fact, shall fulfil specific ergonomic requirements, belonging to three different areas: Polytechnic, Biomedical and Psychosocial (usability and satisfaction).

For each of these areas, specific tests with real users have been performed. The product was therefore compliant with the ergonomic acceptability criteria requested by the standards.







In case several machines are managed by the same operator the repetitive movements will increase and as a consequence of this the related biomechanical risk will increase exponentially.

The possible postural risks are the interaction with the user interface, display and buttons.

Follow the below recommendations to avoid, as much as possible, operators acquiring bodily injury.

- Make sure there are suitable trolleys or baskets for loading, unloading and transportation.
- Organize job rotation in the working place in the case several machines are managed by the same operator.

## 1.6 Symbols

	Caution
	Caution, hot surface
	Caution, high voltage
	Warning, risk of fire / flammable material
	Danger, crush hazard
	Read the instructions before using the machine



## 2 Warranty terms and exclusions

If the purchase of this product includes warranty coverage, warranty is provided in line with local regulations and subject to the product being installed and used for the purposes as designed, and as described within the appropriate equipment documentation.

Warranty will be applicable where the customer has used only genuine spare parts and has performed maintenance in accordance with Electrolux Professional user and maintenance documentation made available in paper or electronic format.

Electrolux Professional strongly recommends using Electrolux Professional approved cleaning, rinse and descaling agents to obtain optimal results and maintain product efficiency over time.

The Electrolux Professional warranty does not cover:

- service trips cost to deliver and pick up the product;
- installation;
- training on how to use/operate;
- replacement (and/or supply) of wear and tear parts unless resulting from defects in materials or workmanship reported within one (1) week from the failure;
- correction of external wiring;
- correction of unauthorized repairs as well as any damages, failures and inefficiencies caused by and/or resulting from;
  - insufficient and/or abnormal capacity of the electrical systems (current/voltage/frequency, including spikes and/or outages);
  - inadequate or interrupted water supply, steam, air, gas (including impurities and/or other that does not comply with the technical requirements for each appliance);
  - plumbing parts, components or consumable cleaning products that are not approved by the manufacturer;
  - customer's negligence, misuse, abuse and/or non-compliance with the use and care instructions detailed within the appropriate equipment documentation;
  - improper or poor: installation, repair, maintenance (including tampering, modifications and repairs carried out by third parties not authorized third parties) and modification of safety systems;
  - Use of non-original components (e.g.: consumables, wear and tear, or spare parts);
  - environment conditions provoking thermal (e.g. overheating/freezing) or chemical (e.g. corrosion/oxidation) stress;
  - foreign objects placed in- or connected to- the product;
  - accidents or force majeure;
  - transportation and handling, including scratches, dents, chips, and/or other damage to the finish of the product, unless such damage results from defects in materials or workmanship and is reported within one (1) week of delivery unless otherwise agreed;
- product with original serial numbers that have been removed, altered or cannot be readily determined;
- replacement of light bulbs, filters or any consumable parts;
- any accessories and software not approved or specified by Electrolux Professional.

Warranty does not include scheduled maintenance activities (including the parts required for it) or the supply of cleaning agents unless specifically covered within any local agreement, subject to local terms and conditions.

Check on Electrolux Professional website the list of authorized customer care.

### 3 Operating panel

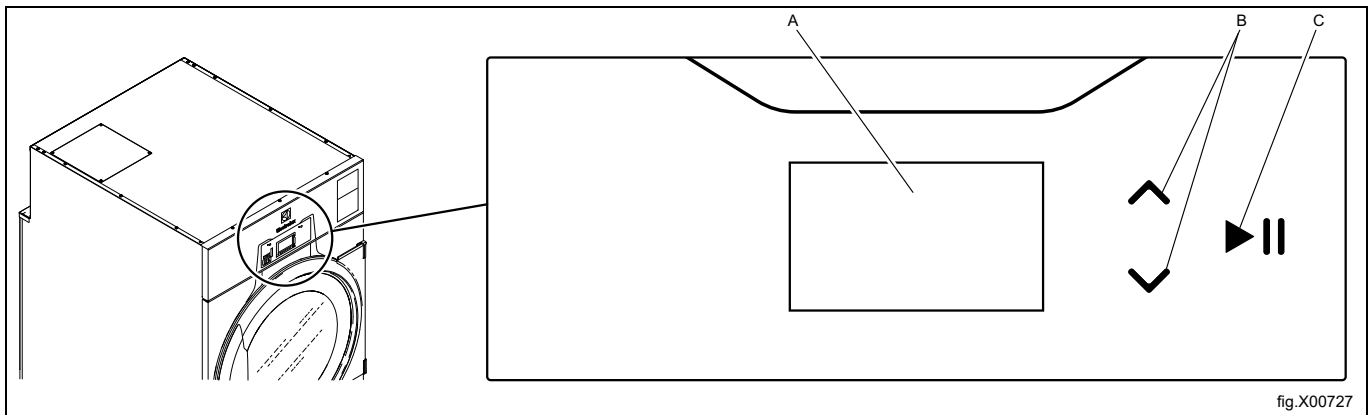

fig.X00727

A	Display
B	Up- and down arrows that are used to scroll up and down through the menus on the display.
C	Start- and pause button

## 4 Program description

### 4.1 General

The machine is equipped with a number of programs adapted to the range of use to which the machine is intended — different markets use different programs. The following program description is a short description of some examples of programs that can be used.

For best possible drying result it is advisable to dry garments of the same quality for each drying cycle.

### 4.2 Program description

There are two types of programs, automatic programs and time programs.









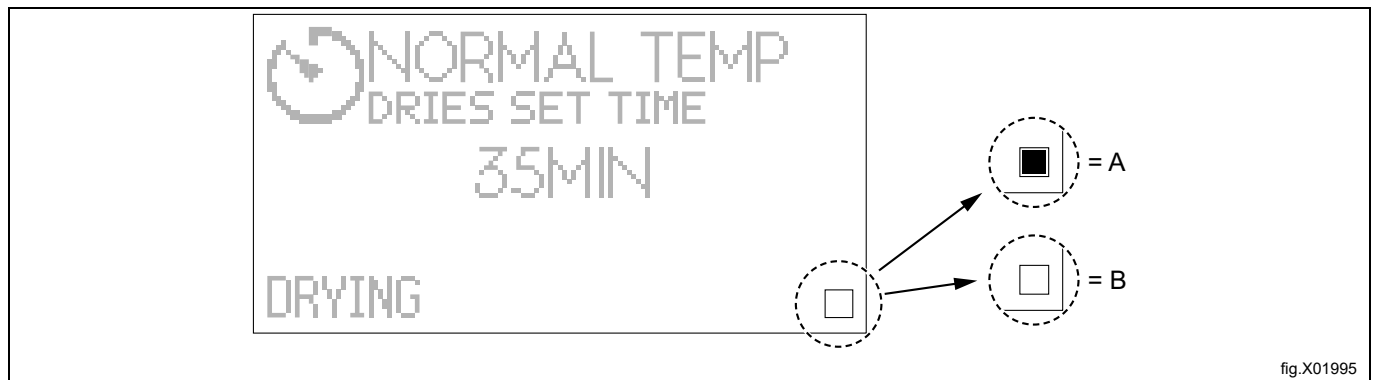







- Automatic programs has moisture detection and will stop when selected dryness is achieved.
- Time programs has no moisture detection and will stop when the preset or selected time has ended.

During a drying cycle, when the square in the lower right corner is fully ticked, it indicates that the heating unit is active / ON. The heating unit can be gas, electric, steam or heat pump type.

If the square box is not ticked, it doesn't mean the heating unit is abnormal. This box is just monitoring the status of the heating unit and shows if it is Active / ON or Inactive / OFF.





- A = Active / ON
- B = Inactive / OFF



Automatic programs		Description
High Temp 	Extra Dry	Denim and terry The program will stop when set dryness is achieved
Medium Temp 	Extra Dry	Denim and terry The program will stop when set dryness is achieved
Low Temp 	Extra Dry	Viscose and polycotton The program will stop when set dryness is achieved
High Temp 	Dry	Cotton and terry The program will stop when set dryness is achieved
Medium Temp 	Dry	Cotton and terry The program will stop when set dryness is achieved
Low Temp 	Dry	Synthetic (example of synthetic fabrics: polyester, polyamide, polyacrylic and elastan), viscose, polycotton and delicate fabrics. The program will stop when set dryness is achieved
High Temp 	Iron Dry	Cotton The program will stop when set dryness is achieved
Medium Temp 	Iron Dry	Cotton The program will stop when set dryness is achieved
Low Temp 	Iron Dry	Synthetic (example of synthetic fabrics: polyester, polyamide, polyacrylic and elastan), viscose, polycotton and delicate fabrics. The program will stop when set dryness is achieved
Low Temp 	Down	The drying time has to be adjusted according to garment type to achieve the desired dryness This program is suitable when drying for example duvet jacket, duvet quilt, duvet pillow.
Low Temp 	Sensitive	This program is suitable when drying for example man made fiber textiles like polyester, polyamide, natural fiber textiles (silk textiles).
Wool 		The program will stop before the garments are totally dry — which protects the garments. This very gentle program is suitable when drying for example woolen garments of more or less all types. For example blankets, jackets etc
Low Temp 	Mops	The program will stop when the mops are dry. This program is suitable when drying for example synthetic microfibre mops.
Low Temp 	Cloths	The program will stop when the cloths are dry. This program is suitable when drying for example synthetic microfibre cloths.
High Temp 	Large Textiles	The program will stop automatically when the fabric is dry. This program is suitable when drying large fabrics such as bed sheets, table cloths, curtains etc. The program is built to prevent the fabric from tangling together.
Medium Temp 	Large Textiles	The program will stop automatically when the fabric is dry. This program is suitable when drying large fabrics such as bed sheets, table cloths, curtains etc. The program is built to prevent the fabric from tangling together.

Automatic programs		Description
Low Temp 	Large Textiles	The program will stop automatically when the fabric is dry. This program is suitable when drying large fabrics such as bed sheets, table cloths, curtains etc. The program is built to prevent the fabric from tangling together.

The following table shows some examples of available time programs and a short description of those. Time programs is for example used on coin operated machines.

Time programs		Description
High Temp 	Dries set time	Cotton and terry The program will stop when the time is up.
Medium Temp 	Dries set time	Cotton and terry The program will stop when the time is up.
Low Temp 	Dries set time	Synthetic (example of synthetic fabrics: polyester, polyamide, polyacrylic and elastan), viscose, polycotton and delicate fabrics. The program will stop when the time is up.
No Heat 	Dries set time	Airing bedspreads, duvets and bedclothes The program will stop when the time is up.

### 4.3 Automatic fan control

If the machine is equipped with automatic fan control the machine is able to self-optimize the air flow according to installation- and running conditions.

If machines with automatic fan control stands next to machines without automatic fan control they will behave and sound completely different.

## 5 Handling

### 5.1 Load

#### Note!

Remove all objects from pockets and make sure there are no metal objects such as screws, pins etc. left. Metal objects might cause damage to the drum.

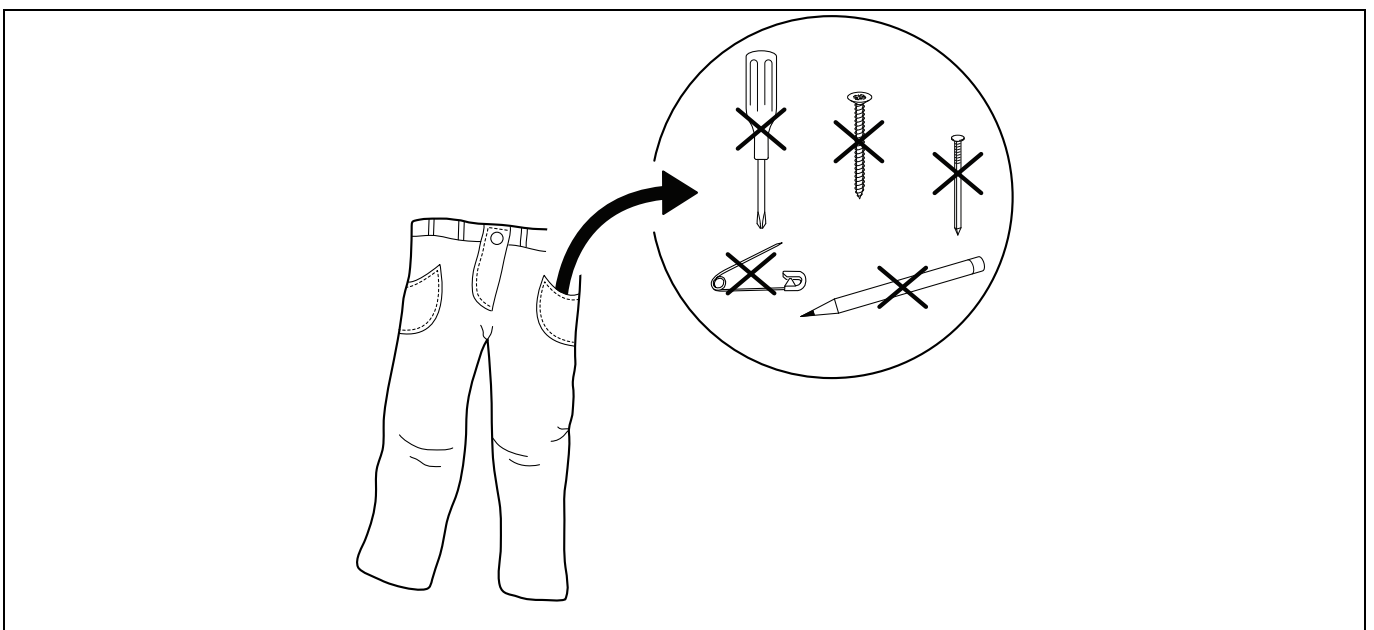

Make sure the filter is clean.

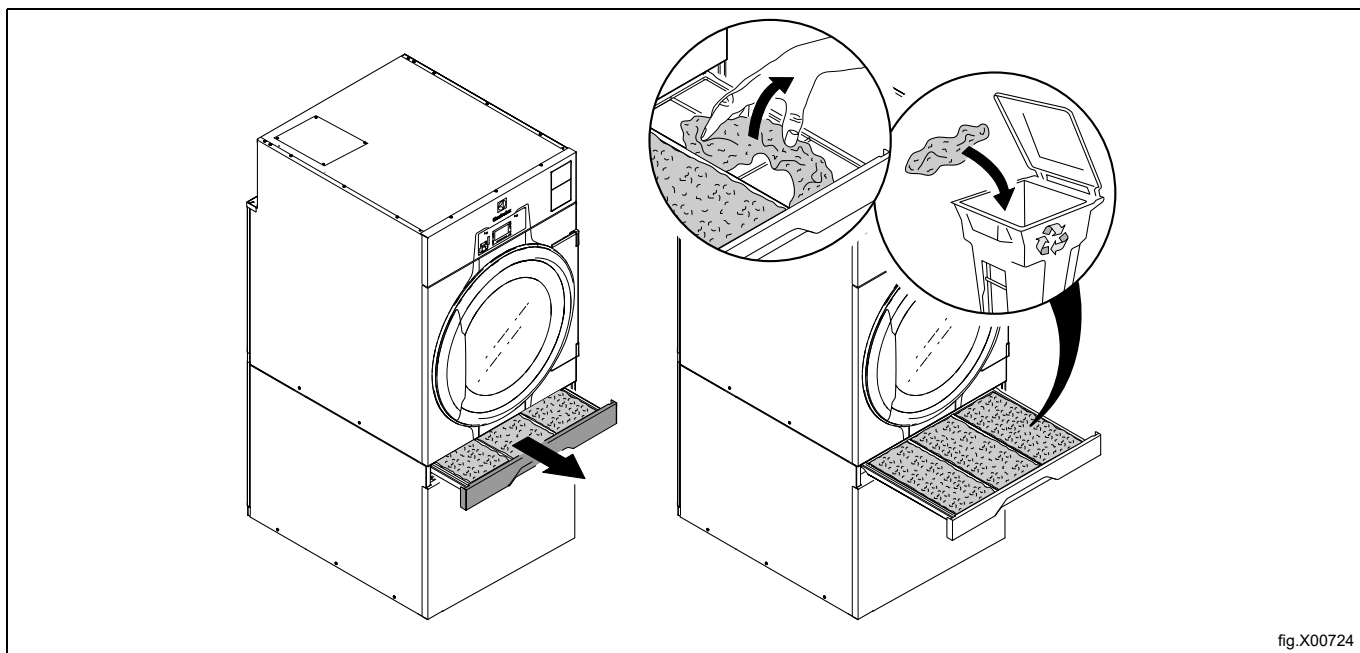

fig.X00724

Load the goods into the machine and close the door.  
The recommended maximum load is 20 kg / 44 lbs.

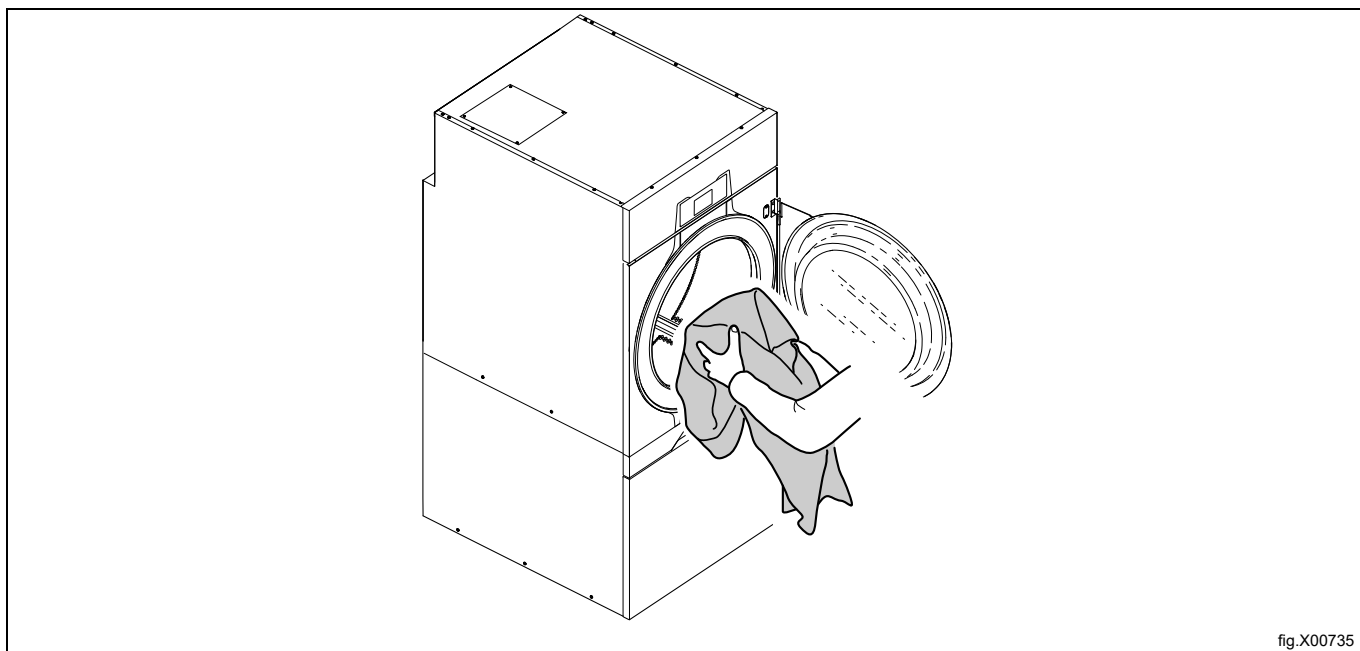





fig.X00735

## 5.2 How to start the machine

### Automatic programs



Select program with the up- and down arrows.

Example of programs
MEDIUM 
LOW 

Start the machine by pressing  .



### Time programs

Select program with the up- and down arrows.

Example of programs
MEDIUM 
LOW 
NO HEATING 

Start the machine by pressing  .

After start it is possible to change the time for the selected program:

- Increase or decrease the time with the up- and down arrows,  
 increases the time and  decreases the time.
- Press  to start again.

### Coin operated machines

Insert correct amount of coins to start the machine and/or press  .

After start it is possible to add time for the selected program. Insert more coins to add time.

## 5.3 Additional functions

There is a menu with additional functions available for selection after start. When pressing  the menu will appear on the display.

Select from the menu with the up- and down arrows and press  to activate.

### Note!

**Some of the functions may not be available or active on your machine.**

### Pause

It is possible to pause an ongoing program.

Select PAUSE and activate.

For some machines it is also possible to pause directly when pressing  .

When pressing  again the program will continue.

### End a program

It is possible to end a program after start.

Select **END PROGRAM** and activate.

When pressing **▶||** the program will be ended.

### Status

Select **STATUS MENU** and activate.

The status menu shows the status for inlet air temp, outlet air temp, RMC and if the heat is on or off in the machine.

### Change drum speed (only on machines with DCS)

Select **CHANGE DRUM SPEED** and activate.

Change the drum speed with the up- and down arrows and press **▶||** to activate.

Use the following table as a guide to set the optimum drum speed.

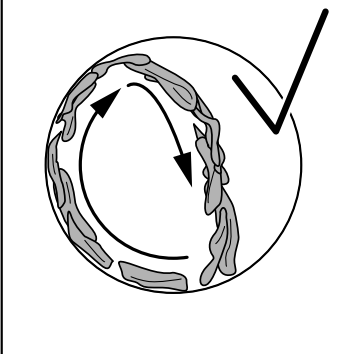
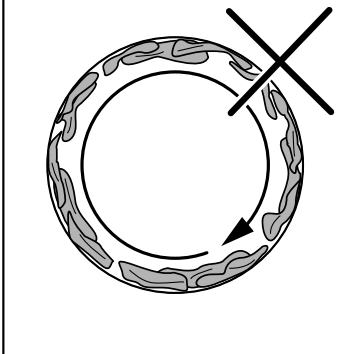
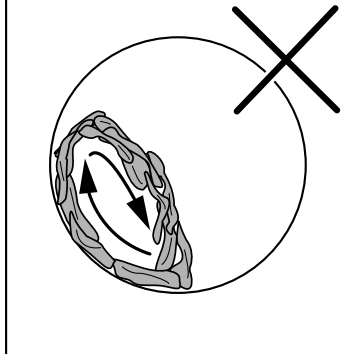
Optimum drum speed	Too fast drum speed	Too slow drum speed
		

The table of optimum drum speed is a general recommendation. Optimal drum speed and how the load should be distributed in the drum can vary depending on type of load and drying process, the table should thus be seen as general load distribution recommendation.

## 5.4 When program has ended

### Note!

**For the best possible drying result it is important to empty the machine as soon as the program has ended.**

If the machine is not emptied as soon as the program has ended the drum will rotate in short intervals in order to keep the goods from being wrinkled.



**Clean the filter**

The filter must be cleaned after each drying cycle.

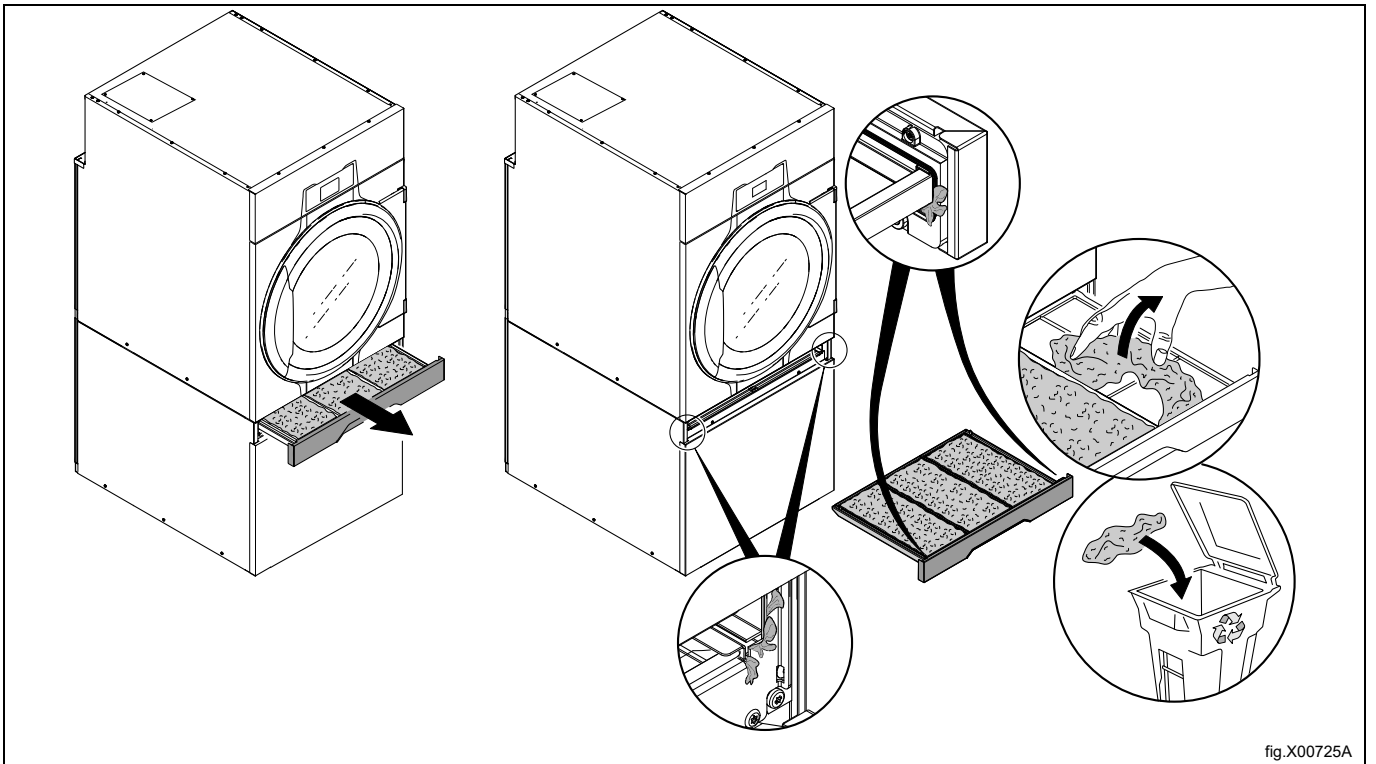

fig.X00725A

Leave the door open when ready. This is to prevent that moisture stays in the machine and develop bacteria and mould.

## 6 Error codes

A fault in the program or in the machine is indicated by an error code on the display. Some of these error codes can be solved easily without contacting service personnel.

Error code	Text	Cause/Action
12:11	DRYING ERROR WITH RMC PROGRAM	The RMC system (Residual moisture system) in the machine indicates that the garment is not dry enough within the maximum drying time. Check that the machine is not overloaded. Check the parameter setting for max. drying time. Check for blown fuses in mains power supply or that steam or gas supply is sufficient and valve is open.
12:17	AIRFLOW OBSTRUCTED. CONTACT RESPONSIBLE .	Machine indicates that internal filters are clogged and must be cleaned. Contact the responsible/owner of the machine to clean the internal filters according to the Maintenance manual. Restart the machine to clear the error message.
12:18	REDISTRIBUTION OF LOAD NEEDED	Machine indicates that load is blocking the airflow. Redistribute the load. Restart the machine to clear error message.
20:1	O.H. DRUM MOTOR	Machine indicates that drum motor is overheated. Wait 30 minutes to allow the motor to cool. Press ►   to clear error message.
30:1	O.H. FAN MOTOR	Machine indicates that the fan motor is overheated. Wait 30 minutes to allow the motor to cool. Press ►   to clear error message.

For other error codes or repeated error codes, disconnect the power for 30 seconds. If the error code keeps coming back, contact authorized service personnel.

## 7 Maintenance

### 7.1 General

It is the responsibility of the owner of the machine/the laundry manager to make sure that maintenance is periodically performed.

Check the “Maintenance manual” for a complete guide on the maintenance to be performed by the owner of the machine/the laundry manager and also by qualified service personnel.

#### **Note!**

**Lack of maintenance may deteriorate the performance of the machine and may cause damage to components.**

### 7.2 Time for maintenance

When the display is showing the message `TIME FOR MAINTENANCE` — contact the owner of the machine/the laundry manager to perform maintenance (if available, a telephone number and/or a tag will also be displayed).

The machine can be used meanwhile. However, the message will keep coming back until the service is performed.

The message will disappear after about 30 seconds or if **▶||** is pressed.

### 7.3 Every day

Check that the machine stops if the door or the filter drawer is opened, if so, the machine must be placed out of order until repairs are made.

Clean the door, door glass, door gasket and other external parts.

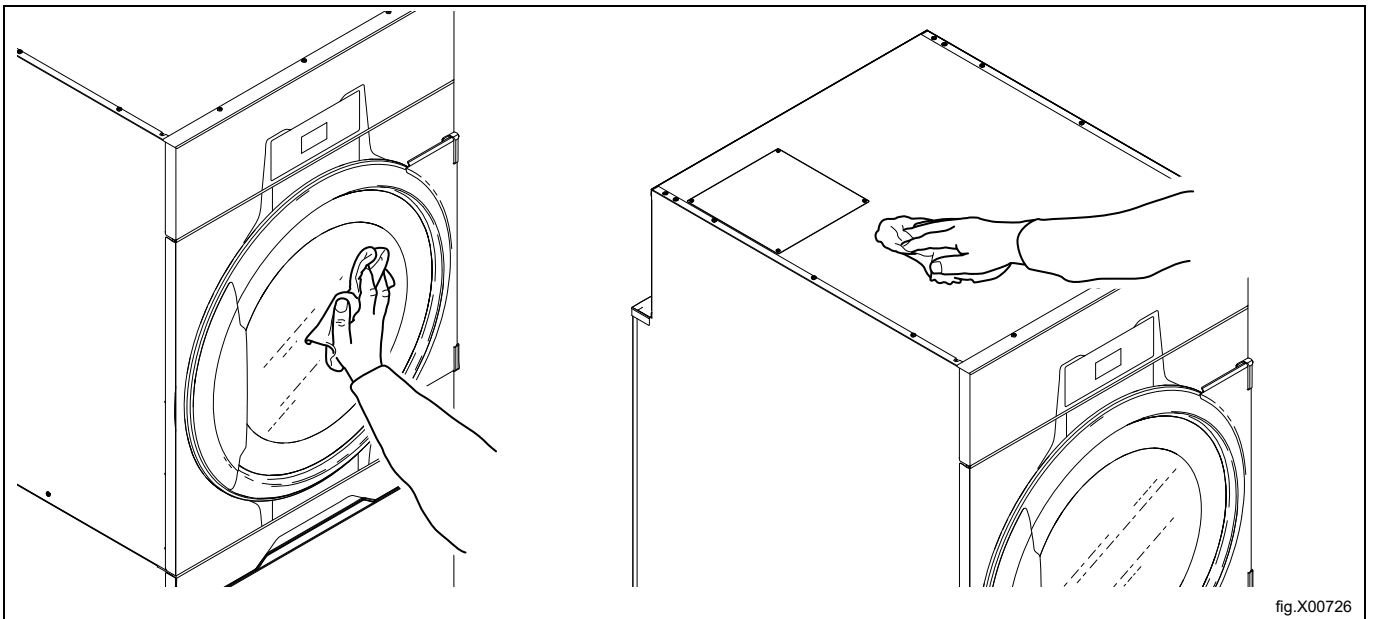
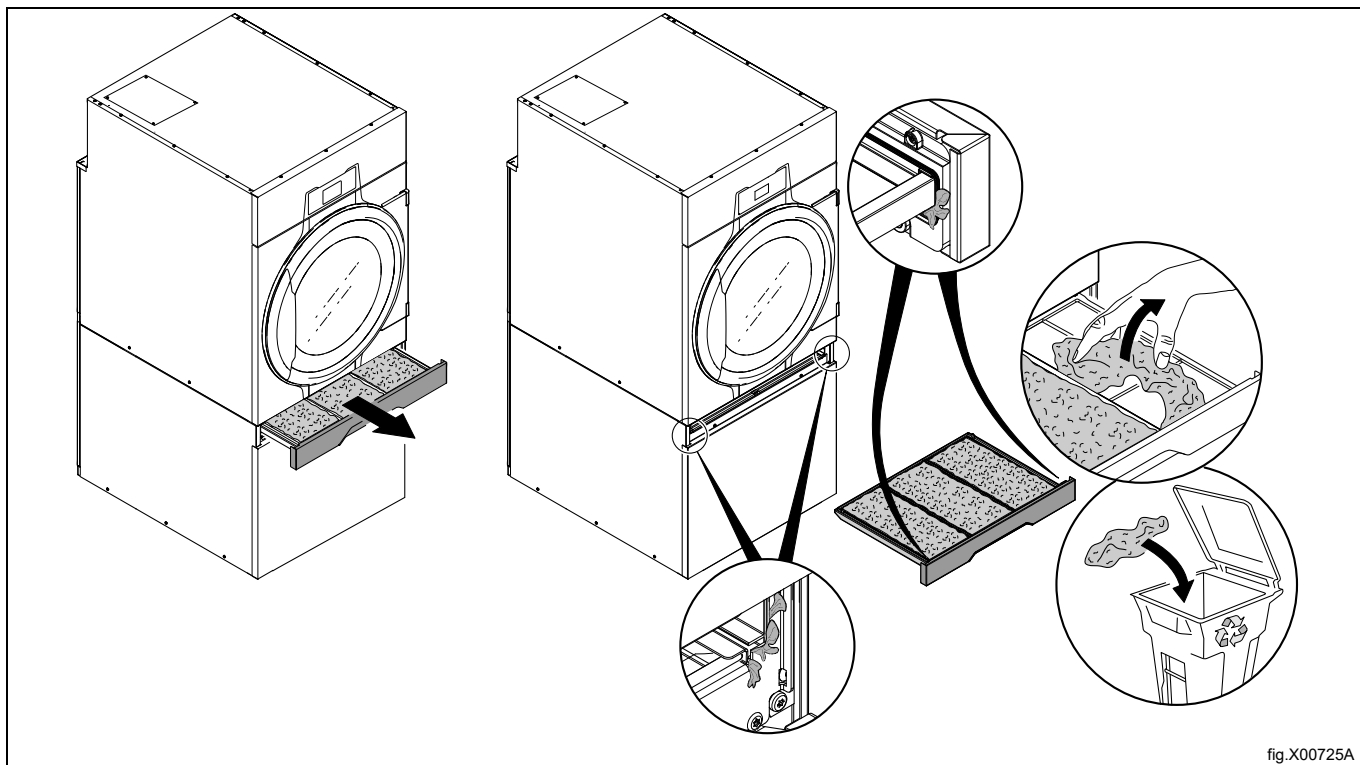

fig.X00726

Clean the filter and filter drawer. Check that the parts are not damaged.



Remove any lint and dust around the machine.



## 7.4 Machines with heat pump

### 7.4.1 Second lint filter

There are two warning messages indicating that the second filter shall be cleaned:

1. "CLEAN FIRST AND SECOND FILTER."
2. "CLEAN FIRST AND SECOND FILTER. IF NOTICE REMAINS, CONTACT RESPONSIBLE FOR CHANGING THE SPECIAL FILTER."

If the first and second filter has been cleaned but the warning message remain on the next drying cycle, the special filter must be cleaned or replaced. Contact the owner of the machine/the laundry manager to clean or replace the special filter.

Remove the filter drawer and pull out the second lint filter.

Clean the second lint filter.

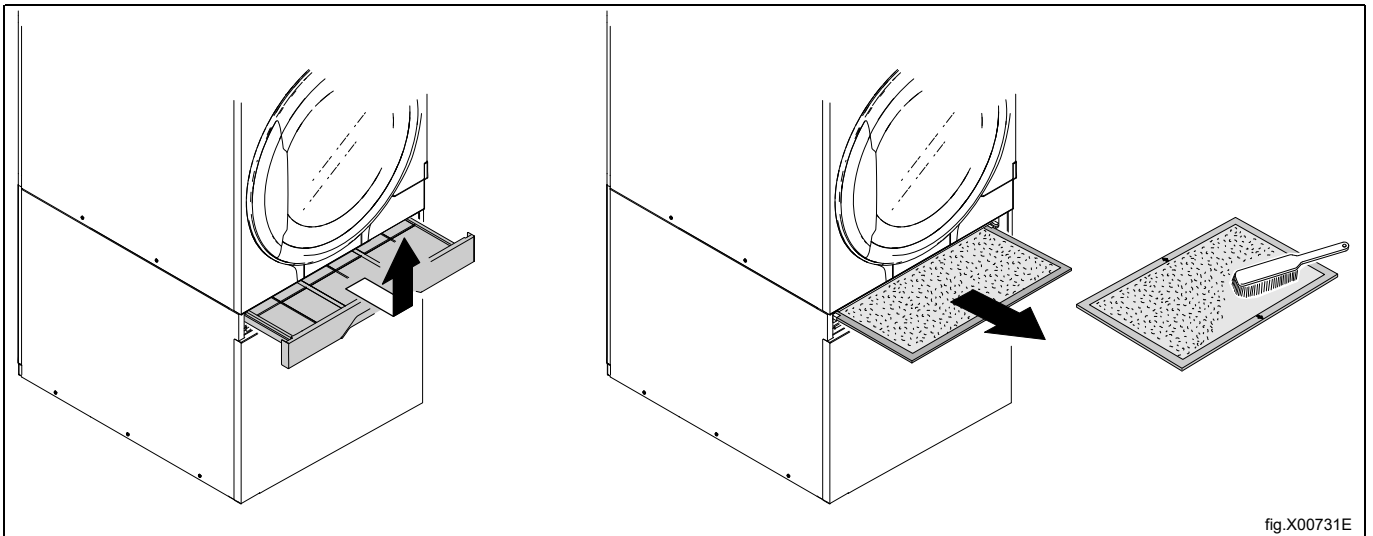

When the second lint filter has been cleaned, insert the second lint filter and the filter drawer.

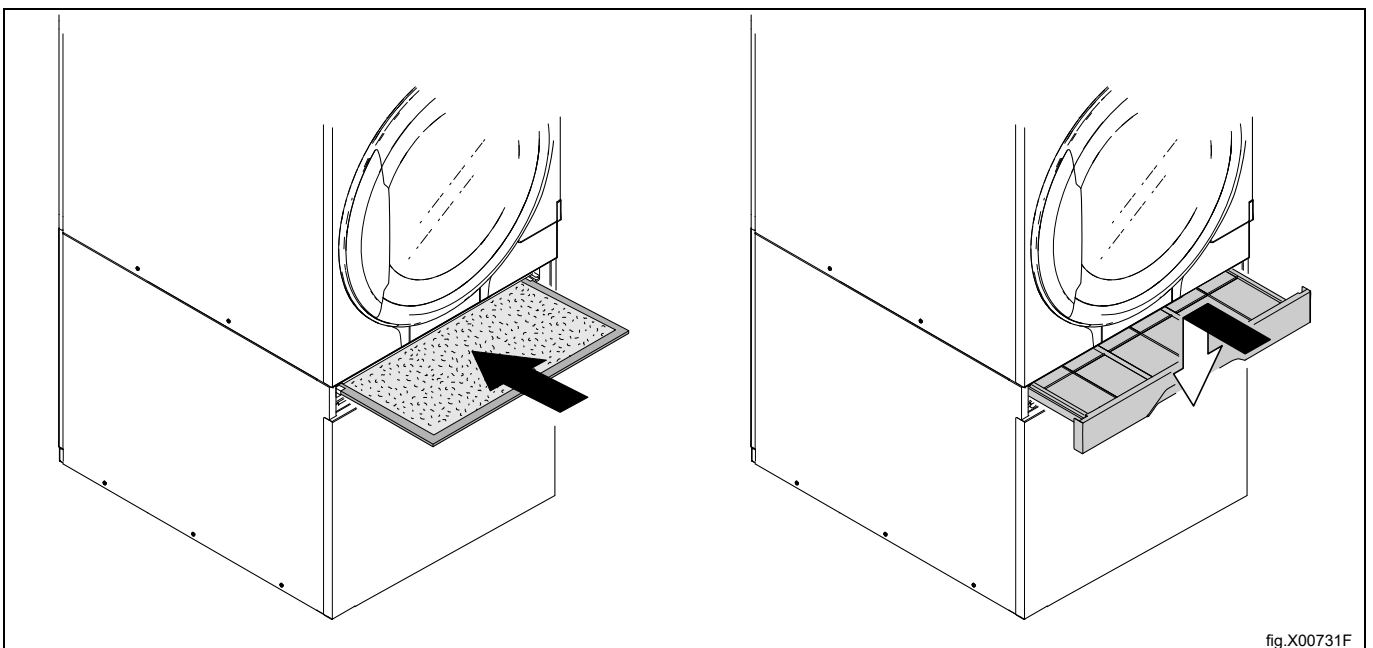

## 8 Disposal information

### 8.1 Disposal of appliance at end of life

Before disposing of the machine, make sure to carefully check its physical condition, and in particular any parts of the structure that can give or break during scrapping.

The machine's parts must be disposed of in a differentiated way, according to their different characteristics (e.g. metals, oils, greases, plastic, rubber, etc.).

Different regulations are in force in the various countries, therefore comply with the provisions of the laws and competent bodies in the country where scrapping takes place.

In general, the appliance must be taken to a specialised collection/scrapping centre.

Dismantle the appliance, grouping the components according to their chemical characteristics, remembering that the compressor contains lubricant oil and refrigerant fluid which can be recycled, and that the refrigerator and heat pump components are special waste assimilable with urban waste.

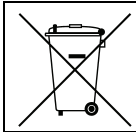

The symbol on the product indicates that this product should not be treated as domestic waste, but must be correctly disposed of in order to prevent any negative consequences for the environment and human health. For further information on the recycling of this product, contact the local dealer or agent, the Customer Care service or the local body responsible for waste disposal.



#### Note!

**When scrapping the machine, any marking, this manual and other documents concerning the appliance must be destroyed.**

### 8.2 Disposal of packing

The packing must be disposed of in compliance with the current regulations in the country where the appliance is used. All the packing materials are environmentally friendly.

They can be safely kept, recycled or burned in an appropriate waste incineration plant. Recyclable plastic parts are marked as following examples.

	Polyethylene: <ul style="list-style-type: none"> <li>• Outer wrapping</li> <li>• Instructions bag</li> </ul>
	Polypropylene: <ul style="list-style-type: none"> <li>• Straps</li> </ul>
	Polystyrene foam: <ul style="list-style-type: none"> <li>• Corner protectors</li> </ul>





[www.electroluxprofessional.com](http://www.electroluxprofessional.com)